



PAT 4142-00 Application: 6550 80W
 This 80 Watts Push Pull output transformer has a primary impedance of 4 kOhms with secondary output taps at 4 Ohms, 8 Ohms and 16 Ohms. This transformer can handle large anode voltages (560 Volts or higher), offering a mild load to the output power tubes like KT66, 6550, KT88 etc. Triode, Ultra Linear (34%) and Pentode configurations are possible. The power bandwidth starts at a low 14 Hz while extending up to 96 kHz without any form of negative feedback.

Toroidal Output Transformer for Tube Amplifiers

Visit us on the web:

www.plitron.com

Special Toroidal Output Transformer Designs

PAT-4142-00 Ratings

Type & Application	4 OHM	8 OHM	16 OHM	
Primary Impedance	Raa = 3.943	Raa = 3.961	Raa = 3.998	[kΩ]
Secondary Impedance	Rls = 4	Rls = 8	Rls = 16	[Ω]
Turns Ratio Np/Ns	Ratio = 31.397	Ratio = 22.252	Ratio = 15.807	[]
Ultra Linear Tapping at	tap = 33	tap = 33	tap = 33	[%]
-1 dB Frequency Range [Hz to KHz] ⁽³⁾	flf = 1.659 fhf = 24.028	flf = 1.661 fhf = 23.941	flf = 1.663 fhf = 23.871	
-1 dB Frequency Range [Hz to KHz] ⁽³⁾	fl1 = 0.708 fh1 = 47.484	fl1 = 0.708 fhf = 47.385	fl1 = 0.709 fh1 = 47.303	[kHz]
-3 dB Frequency Range [Hz to KHz] ⁽³⁾	fl3 = 0.36 fh3 = 75.864	fl3 = 0.361 fhf = 75.791	fl3 = 0.361 fh3 = 75.73	[kHz]
Nominal Power ⁽¹⁾	Pn = 80	Pn = 80	Pn = 80	[W]
-3 dB Power Bandwidth starting at	fu = 14	fu = 14	fu = 14	[Hz]
Total Primary Inductance ⁽²⁾	Lp = 996	Lp = 996	Lp = 996	[H]
Primary Leakage Inductance	lsp = 6	lsp = 6	lsp = 6	[mH]
Effective Primary Capacitance	cip = 1	cip = 1	cip = 1	[nF]
Total Primary DC Resistance	Rip = 78	Rip = 78	Rip = 78	[Ω]
Total Secondary DC Resistance	Ris = 0.11	Ris = 0.2	Ris = 0.28	[Ω]
Tubes Plate Resistance per section	ri = 2.5	ri = 2.5	ri = 2.5	[kΩ]
Insertion Loss	lloss = 0.201	lloss = 0.19	lloss = 0.158	[dB]
Q-factor 2nd order HF roll-off ⁽⁵⁾	Q = 0.621	Q = 0.62	Q = 0.62	[]
HF roll-off Specific Frequency ⁽⁵⁾	Fo = 87.798	Fo = 87.84	Fo = 87.875	[kHz]
Quality Factor ⁽⁵⁾	QF = 1.66·10 ⁵	QF = 1.66·10 ⁵	QF = 1.66·10 ⁵	[]
Quality Decade Factor = log(QF) ⁽⁵⁾	QDF = 5.22	QDF = 5.22	QDF = 5.22	[]
Tuning Factor ⁽⁵⁾	TF = 1.269	TF = 1.266	TF = 1.264	[]
Tuning Decade Factor = log(TF) ⁽⁵⁾	TDF = 0.104	TDF = 0.103	TDF = 0.102	[]
Frequency Decade Factor ^(4,5)	FDF = 5.324	FDF = 5.323	1FDF = 5.322	[]

(1): calculated under the conditions of balancing the DC-currents and the AC-anode voltages of the powertubes driving the transformer

(2): maximum value, measured over secondary, transfered to primary

(3): calculation at 1 mWatt in Rls; ri and Rls are pure Ohmic

(4): defined as FDF = log(fh3/fl3) = number of frequency decades transfered

(5): ir. Menno van der Veen; Theory and Practise of Wide Bandwidth Toroidal Output Transformers; preprint 3887, 97th AES Convention San Fransico

(C): Copyright 1994 Vanderveen; Version 1.7; design date December 4, 1998

PAT-4142-00 Response Curves

4 OHM

8 OHM

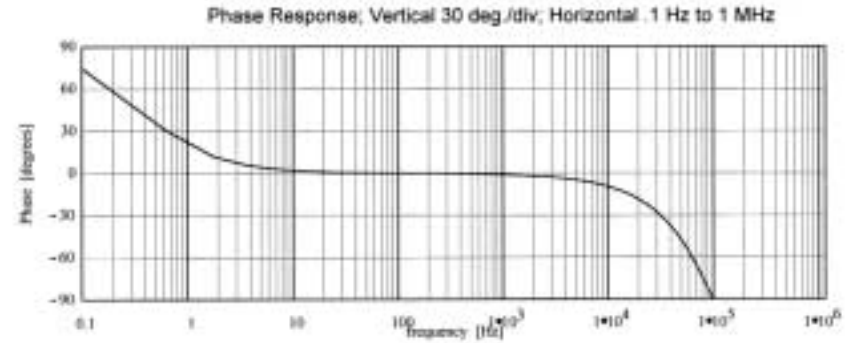
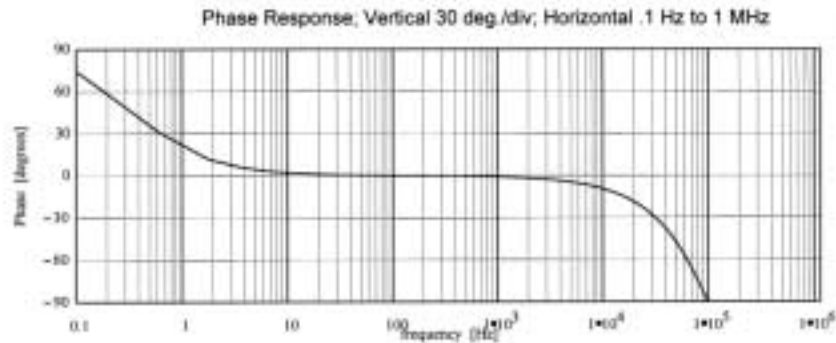
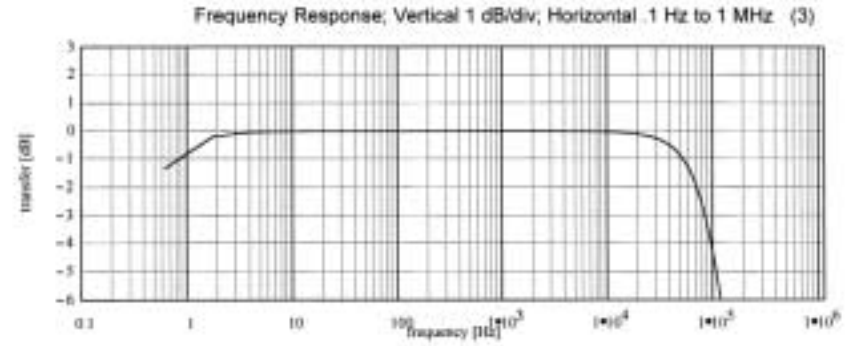
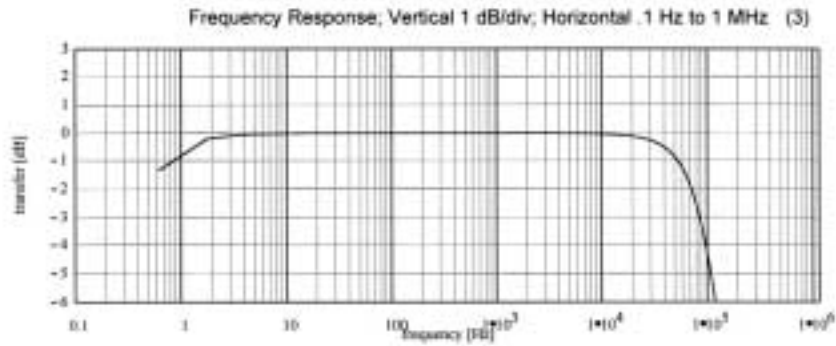

Differential Phase Distortion; vert. 30 deg./div; hor. .1 Hz to 1 MHz
See: W.M.Leach, Differential Time Delay...; JAES sept.89 pp.709-715

Differential Phase Distortion; vert. 30 deg./div; hor. .1 Hz to 1 MHz
See: W.M.Leach, Differential Time Delay...; JAES sept.89 pp.709-715

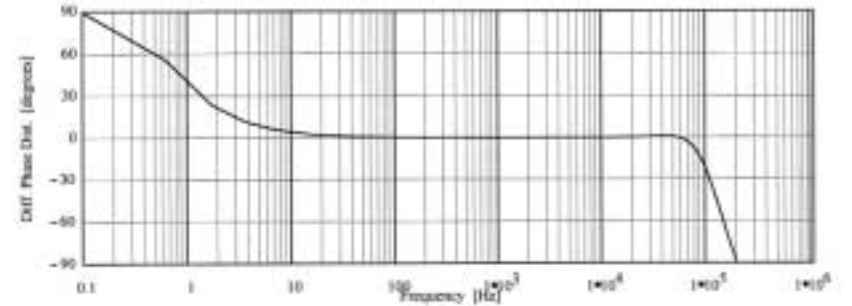
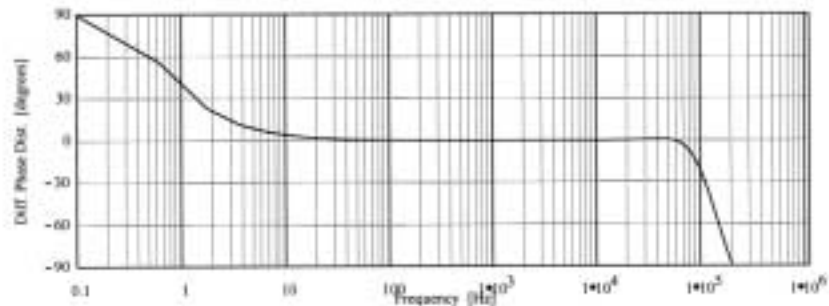

(C): Copyright 1994; Ir. buro Vanderveen

(C): Copyright 1994; Ir. buro Vanderveen

PAT-4142-00 Response Curves

16 OHM

Frequency Response; Vertical 1 dB/div; Horizontal .1 Hz to 1 MHz (3)

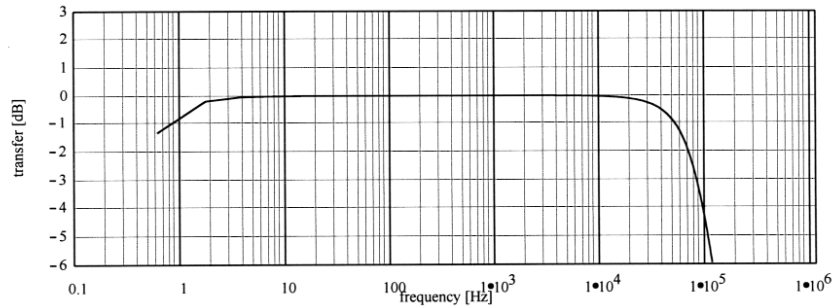

Phase Response; Vertical 30 deg./div; Horizontal .1 Hz to 1 MHz

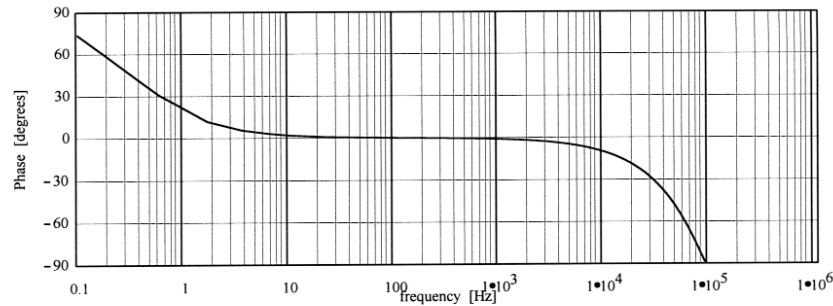

Differential Phase Distortion; vert. 30 deg./div; hor. .1 Hz to 1 MHz

See: W.M.Leach, Differential Time Delay.; JAES sept.89 pp.709-715

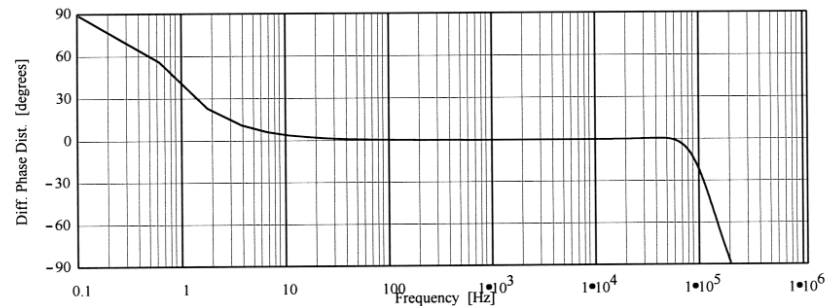

(C): Copyright 1994: Ir. buro Vanderveen

Schematic

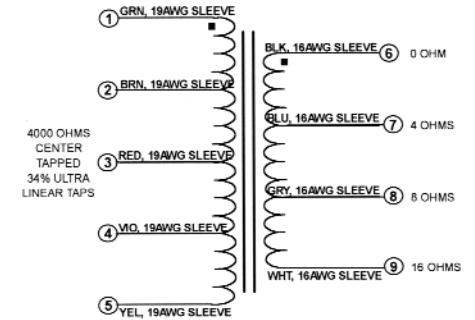

Mechanical

REF	Dimension, in mm
A	152.4 nominal
B	88.9 nominal
C	5/16-18 T-NUT
D	20 +/- 5 (2 places)
E	70 +/- 5 (2 places)

Weight: 5.2kg
Lead Length: 200mm (+/- 10mm)

