



NITTOCON

ニットーコンは当社が長年研究の結果、厳選された酸化チタン、チタン酸バリウムを主原料として成形・焼成された磁器コンデンサの商品名で、高周波電力機器として放送機、無線通信機、超音波応用機械、各種電子機器、高周波焼入装置、高周波加熱装置等の各回路内に欠くことのできない部品となり、その他、多方面に広い用途を持ち、躍進エレクトロニクス界の発展に伴なって、ますますその利用範囲も拡大されています。

NITTOCON is the trade name we have chosen for the ceramic capacitors produced by our company. They are manufactured through the process of molding and sintering rigidly selected titanium oxide and barium titanate, as the main materials the result of many years of research conducted at our company laboratory. NITTOCON ceramic capacitors have become an indispensable part of the intricate circuits of broadcasting equipment, radio communications equipment, supersonic-applied equipment, various electronic equipment, high-frequency type baking equipment, high-frequency type heating equipment, and so forth.

NITTOCON ceramic capacitors serve in a broad range of applications, and along with the skyrocketing development of the electronics industry, their range of usefulness has been continuously expanding and diversified.

種類 Verieties of NITTOCON

1. 高周波電力用コンデンサ RF・RE・SF・SE
Capacitors for high-frequency power
2. 側路用コンデンサ BE・RE・SE
Capacitors for by-pass

命名 Code System

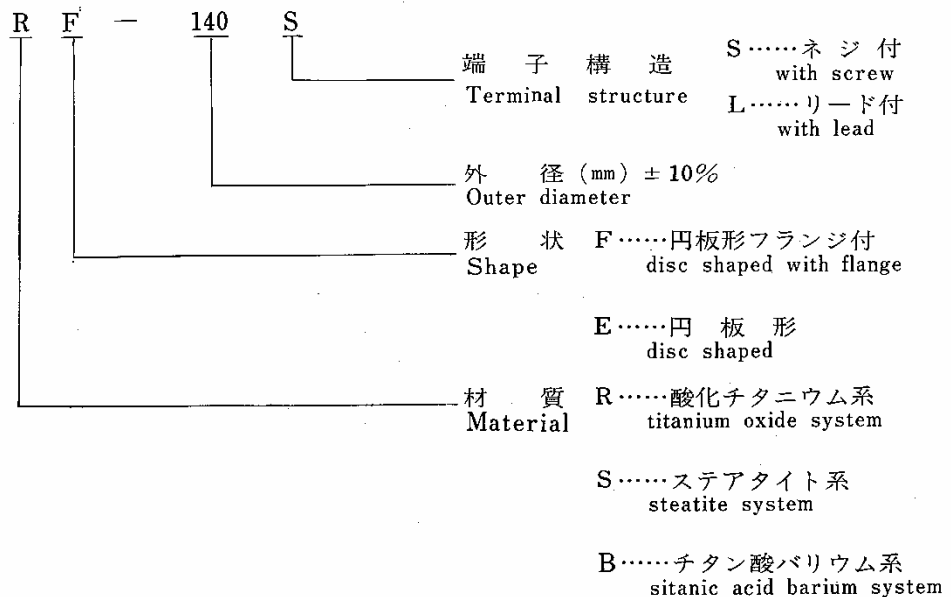

特 長

高周波電力用 (RF・RE・SF・SE)

1. インダクタンスがきわめて少ない。
2. 小形軽量で電力負荷能力が大きい。
3. 絶縁抵抗がきわめて高い。
4. 耐熱, 耐湿に優れ, 湿気による損失の増加・絶縁抵抗の劣化がきわめて少ない。
5. 静電容量の温度係数が直線的, 可逆的である。
6. 電気的性能が経年変化せず, きわめて安定している。
7. 多品種が標準化されている。
8. 取り付けが簡単である。

側路用 (BE・RE・SE)

1. 材質Bは誘電率がきわめて大きいため, 小形で大容量のものが得られ, 残留インダクタンスを極度に小さくできる。
2. 絶縁抵抗および耐湿性は半永久的である。
3. 多品種が標準化されている。

Distinguished Features

For high-frequency power (RF・RE・SF・SE)

1. Surprisingly small inductance.
2. Small-sized and light weight, but large in capacitance.
3. Outstanding insulation resistance.
4. Superb heat-resistant and moistureproof characteristics minimize an increase of loss due to moisture as well as degradation of insulation resistance.
5. Temperature coefficient of electrostatic capacity is straight-lined and reversible.
6. Free from aging and perfectly stabilized in electrical performance.
7. Products of various models are standardized.
8. Easily installed.

For By-Pass (BE・RE・SE)

1. Material B, with its outstandingly high dielectric constant, not only enables large currents to be carried considering their relatively small size but also extremely minimizes residual inductance.
2. Insulation resistance and moisture-resistant characteristic are semi-permanent.
3. Products of various models are standardized.

ニットーコンの構造

Structure of NITTOCON :

ニットーコンは形状により第1図のように磁器素体と銀電極端子とで形成されるきわめて簡単な構造です。磁器素体は 1,200℃以上の高温で焼結し直接銀電極を焼付、その上に端子をハンダ付けし、端子以外の電極表面磁器素体に特殊塗装をほどこしたものです。

NITTOCON has an outstandingly simple structure formed by ceramic main material and silver electrode terminals as shown in Figure 1. The ceramic main material is sintered at a high temperature such as 1200°C or more, and directly baked together with the silver electrode terminal, upon which terminals are welded. The ceramic main material on the surface of the electrode other than terminals is specially coated.

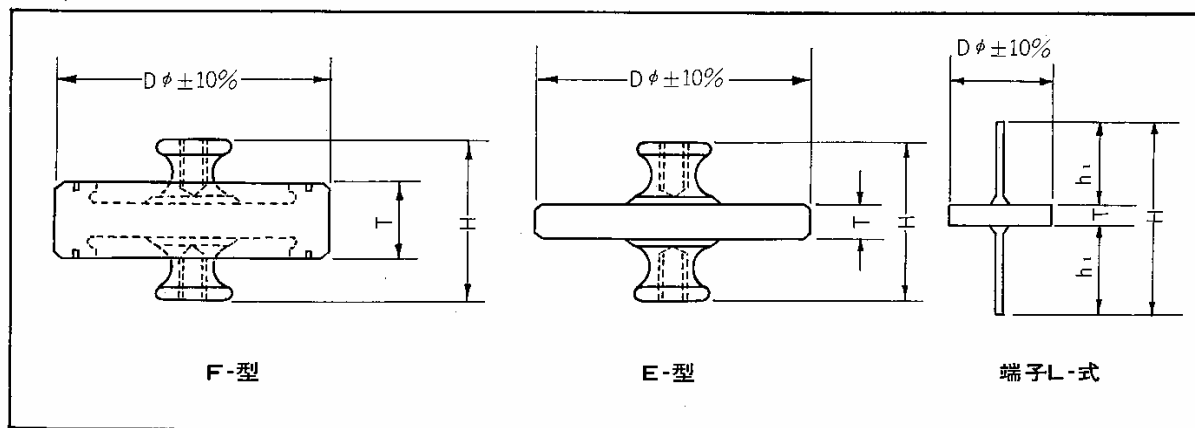
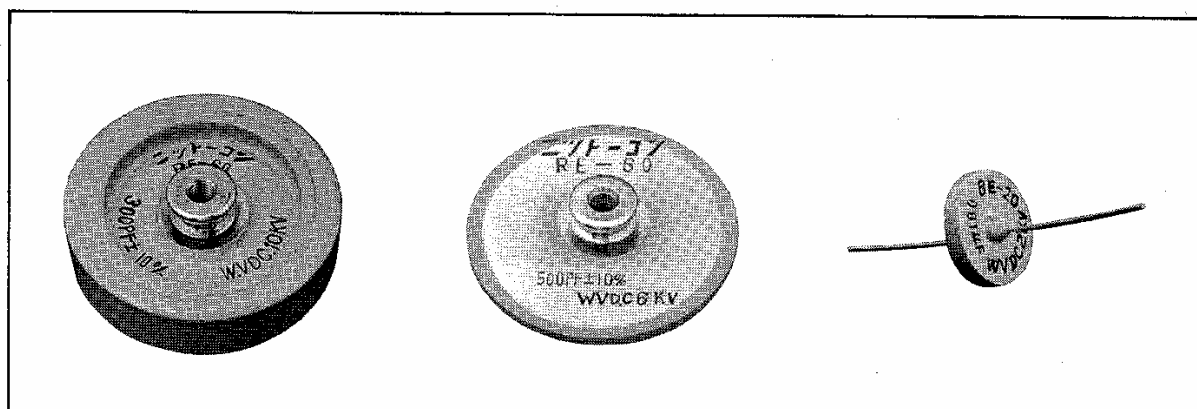

第1図 Table No. 1

端子構造 Terminal Structure

20 S

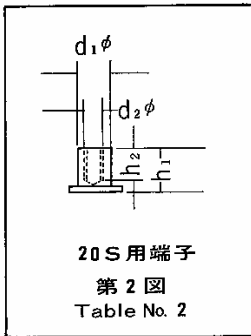

30~110 S

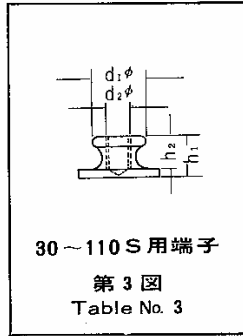

110 S

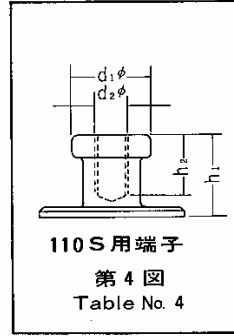

140~160 S

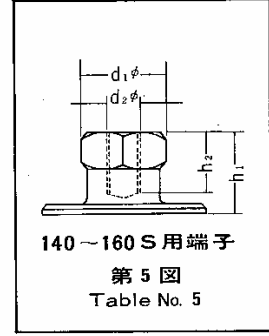

S式 S-type

材質 Material 型名 Type 寸法 Size 記号 Mark	R-S	R-S	R-S	R-S	R-S-B	R-S-B	R-S-B
	F	F	E	FE	FE	FE	E
寸法 Size 記号 Mark	160 140	110	110	80	60 50	40 30	20
$d_1 \phi$	21	22	22	18	15	11	6
$d_2 \phi$	8	8	6	6	6	4	3
h_1	20	20	12.5	12	10	10	8
h_2	15	15	10	10	8	8	6

L式 L-type

材質	R-S-B
型名 Type 寸法 Size	E
記号 Mark	30 20
$d_1 \phi$	1
h_1	30

(單位mm)

L端子使用規格一覽表

Standard Table for Using L - Terminal

定格電圧 (KV) Rated voltage		標準静電容量 Standard electrostatic capacity (PF)																	
直流電圧 DC voltage 50°C	直流電圧 DC voltage 70°C	5	10	15	20	25	50	100	150	200	250	300	400	500	1,000	2,000	5,000	10,000	
5	4						RE-30L												
3	2.5	SE-30L					RE-20L			RE-30L				BE-30L					
2	1.5	SE-20L						RE-20L				RE-30L		BE-20L		BE-30L			
1	0.8																	BE-30L	

電気的特性

材質	絶縁抵抗	容量偏差 at 20°C	誘電体 損失角 at IMC	温度上昇 IMC		静電容量 温度係数	耐湿特性 40°C湿度90%以上 100h放置		使用温度 範囲
				at 50°C	at 70°C		絶縁抵抗	誘電体 損失角	
R	10,000 MΩ 以上	200PF未満±20% 200PF以上±10%	5×10 ⁻⁴ 以下 (Q>2,000)	50°C 以下	30°C 以下	(-650±150) ×10 ⁻⁶	5,000 MΩ 以上	10×10 ⁻⁴ 以下 (Q>1,000)	-10°C+100°C
S	10,000 MΩ 以上	50PF未満±20% 50PF以上±10%	5×10 ⁻⁴ 以下 (Q>2,000)	50°C 以下	30°C 以下	(+100±60) ×10 ⁻⁶	5,000 MΩ 以上	10×10 ⁻⁴ 以下 (Q>1,000)	-10°C+100°C

材質	絶縁抵抗	容量偏差 at 25°C	Q	静電容量 温度係数	耐湿特性 40°C湿度90%以上 50H放置		使用温度 範囲
					絶縁抵抗	Q	
B	2,000 MΩ 以上	±50%	Q>40 (at 1kc)	25°Cの値の ±50%以内	1,000 MΩ 以上	Q>20	-10°C~ +75°C

材質S系で静電容量が30PF未満のQは第6図になります

Electrical Characteristics

Material	Insulation resistance	Deflection of capacity at 20°C	Dielectric loss angle at IMC	Temperature rise IMC		Electrostatic capacitance temperature coefficient	Moistureproof characteristic after being left intact at 40°C, 90% or more humidity for 100 hrs consecutively		Temperature limits used
				at 50°C	at 70°C		insulation resistance	Dielectric loss angle	
R	More than 10,000 M/Ω	Less than 200PF±20% More than 200PF	Less than 5×10 ⁻⁴ (Q>2,000)	Less than 50°C	Less than 30°C	(-650±150) ×10 ⁻⁶	More than 5,000MΩ	Less than 10×10 ⁻⁴ (Q>1,000)	-10°C+100°C
S	More than 10,000 MΩ	Less than 50PF±20% More than 50PF±10%	Less than 5×10 ⁻⁴ (Q>2,000)	Less than 50°C	Less than 30°C	(+100±60) ×10 ⁻⁶	More than 5,000MΩ	Less than 10×10 ⁻⁴ (Q>1,000)	-10°C+100°C

Material	Insulation resistance	Deflection of capacity at 25°C	Q	Electrostatic capacitance temperature coefficient	Moistureproof characteristic after being left intact at 40°C, 90% or more humidity for 50 hrs consecutively		Temperature limits used
					Insulation resistance	Q	
B	More than 2000 MΩ	±50%	Q>40 (at 1kc)	Less than the value at 25°C±50%	More than 1000MΩ	Q>20	-10°C~ +75°C

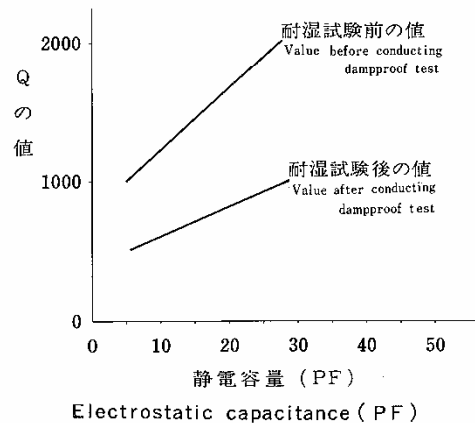

As for the Q with electrostatic capacitance of below 30PF using the S material, please refer to the Table No. 6.

第 6 図
Table No. 6

用 途

中波放送機、無線通信機、TV放送機、超音波応用機械、誘電加熱（高周波マシン）誘導加熱（高周波焼入れ、溶融炉）などの発振、共振、結合回路用

参考事項

本製品は、材質を表示するため、円板上に下記の色別塗装しています。

R (ルチル系) ……緑 S (ステアタイト系)
 ……青 B (バリウム系) ……黄

■ニットーコン型名と他社相当品比較

〔当社型名〕	〔他社相当品〕
RF型 (旧名DF) ……	RDF・DC
RE型 (# DE) ……	RD・DA
SF型 (# DF) ……	SDF・DC
SE型 (# DE) ……	SD・DA
BE型 (# RB) ……	DA

取り扱い上のご注意

- ニットーコンには必要以上の外力（S型約60kg以上、L型約20kg以上）を加えないでください。
- ニットーコンの平面方向間隔は、たがいに20%以上になるよう考慮してください。
- 自然空冷式のため通風の必要はありませんが、強制空冷する場合は均一に空冷できるよう考慮してください。
- 完全焼結品ですから湿度に対する劣化はありませんが、表面に水滴が付着すると表面コロナの原因となりますので、特に水冷管を使用する装置等に使用する場合、水がかからないようにしてください。
- ニットーコンの定格、電圧及び定格電力容量は50℃の値を表示します。
- ニットーコンの定格電力容量は、周囲温度50℃～70℃の値を示していますが、50℃～100℃で使用する場合は第7図により軽減してください。

温度対負荷軽減曲線

Reducing curve of temperature against load

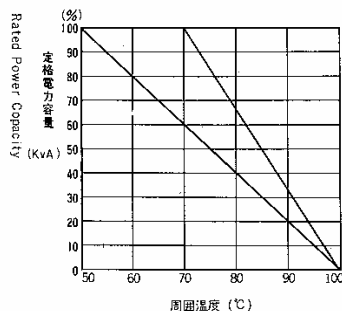

第7図
Table No. 7

Application

For oscillating, resonant, and coupling circuits of medium-wave broadcasting equipment, wireless communication equipment, TV broadcasting equipment, supersonic-applied equipment, dielectric heating (high-frequency machines), inductive heating (high-frequency quenching, melting furnaces), and so forth.

Reference

The disc of this product is painted in order to identify its material as follows :

R (Rutile) ……Green
 S (Steatite) ……Blue
 B (Barium) ……Yellow

■NITTOCON Models Compared with Other Firm's Similar Products

〔Our models〕 〔Other firm's models〕

Model RF (Formerly DF) ……	RDF・DC
RE (# DE) ……	RD・DA
SF (# DF) ……	SDF・DC
SE (# DE) ……	SD・DA
BE (# RB) ……	DA

Precautions on Handling

- Do not apply an external force more than necessary to NITTOCON (approximately 60 kg or more to S-type and approximately 20 kg or more to L-type).
- Give due consideration to keeping NITTOCON at intervals of 20mm or more on the plane.
- Although air circulation is unnecessary because of its natural air-cooling system, adopt measures to cool it evenly with air in case of applying a compulsory air-cooling system.
- Although free from moisture degradation because of its processing by complete sintering, keep NITTOCON away from water especially when it is utilized for equipment which uses water-cooling pipes (drips water clinging to the surface may result in surface corona).
- The rated voltage and the rated capacity of NITTOCON are values at 50°C.
- Although the rated capacity of NITTOCON indicates the value at 50~70°C ambient temperature, decrease the rate according to Figure 7 when using it at 50~100°C.

材 質 R (酸化チタニウム系) 規格表 Material - R (Rutile) Rating Table

形 名 Model	端子形 Terminal Shape	標準静電容量 Standard Ele- ctrostatic Capa- city (PF)		定格電圧 (KV) Rated Voltage			定格電力容量 Rated Power Capacity (KVA)		D ϕ $\pm 10\%$ (mm)	T (mm)	H (mm)	備 考 Remarks
				H・F 尖頭値 Peak Value	D.C.		50℃	70℃				
					50℃	70℃						
RF-140	S	500	600	30	25	20	90	60	140	33~27	53~46	
"	"	700	800	25	21	17	90	60	140	33~27	52~45	
"	"	1500		15	13	10	90	60	140	33~27	50~43	
"	"	2000		9	8	7	67.5	45	140	30~22	47~42	
RF-110	S	200		25	21	17	45	30	110	24~18	55~50	
"	"	300	400	30	25	20	90	60	110	24~18	53~48	
"	"	500	600	18	15	12	45	30	110	24~18	51~45	
"	"	700	800	14	12	10	30	20	110	24~18	49~44	
"	"	1000		12	10	8	30	20	110	18~13	48~43	
"	"	1200	1500	10	8	7	22	14	110	18~13	47~41	
"	"	2000		9	7	6	15	10	110	18~13	46~40	
RF-80	S	100		16	13	11	22	14	80	24~18	40~35	
"	"	200	250 300	18	15	12	30	20	80	24~18	39~29	
"	"	400	500	14	12	10	15	10	80	20~14	32~26	
"	"	600	700	12	10	8	15	10	80	20~14	31~25	
"	"	800	1000	9	8	7	15	10	80	17~12	30~24	
"	"	1200		7	6	5	15	10	80	17~12	29~24	
RF-60	S	150	100 250	14	12	10	15	10	60	24~14	32~22	
"	"	300	400	12	10	8	7.5	5	60	20~14	27~20	
"	"	500	600 700	7	6	5	7.5	5	60	18~12	26~20	
"	"	800	1000	6	5	4	7.5	5	60	15~10	25~20	
RF-50	S	100	150 200	13	11	9	10	6.5	50	17~12	30~21	
"	"	250	300	7	6	5	6	4	50	17~12	26~21	
"	"	400	500	6	5	4	6	4	50	15~10	26~20	
RF-40	S	50	100 150	12	10	8	6	4	40	21~10	36~22	
"	"	200	250 300	6	5	4	4.5	3	40	15~10	26~20	
RF-30	S	50	100 150	6	5	4	3	2	30	15~10	29~22	
RE-110	S	400	500 600 700	2	11	8.5	10	6.5	110	10~6	35~30	
"	"	800	1000	2	8.5	7	10	6.5	110	8~4	33~28	
"	"	1200	1500 2000	2	6	5	10	6.5	110	7~3	32~27	
RE-80	S	300	400 600	2	8.5	7	7	4.5	80	8~3	28~22	
"	"	500	800 1000	2	7	5.5	7	4.5	80	6~2	30~25	
"	"	700	1500	2	6	5	7	4.5	80	5~1	29~24	
RE-60	S	200	250 300	2	7	5.5	5	3.5	60	10~5	30~24	
"	"	400	500 600	2	6	5	5	3.5	60	7~3	27~22	
"	"	700	800 1000	2	5	4	5	3.5	60	5~1	25~20	
RE-50	S	100	150 200 300	2	6	5	4	2.8	50	12~8	32~27	
"	"	250	400 500 600	2	5	4	4	2.8	50	5~1	25~20	
RE-40	S	50	100 150 300	2	5	4	3	2	40	8~1	28~20	
"	"	200	250 500	2	3.5	3	2.2	1.5	40	3~1	23~20	
RE-30	S-L	50	100 200	2	5	4	2	1.2	30	7~1	27~20	
"	"	150	250 300	2	3	2.5	2	1.2	30	4~1	24~20	
"	"	250	400 500	2	2	1.5	1.5	1	30	3~0.5	23~19	
RE-20	S-L	50	100	2	3	2.5	1.5	1	20	5~1	21~16	
"	"	150	200	2	2	1.5	1.5	1	20	3~0.5	19~15	

材 質 S (ステアタイト系) 規格表
Material-S (Steatite) Rating Table

形 名 Model	端子形 Terminal Shape	標準静電容量 Standard Ele- ctrostatic Capa- city (PF)	定格電圧 (KV) Rated Voltage			定格電力容量 Rated Power Capacity (KVA)		D ±10% (mm)	T (mm)	H (mm)	備 考 Remarks
			H・F 尖頭値 Peak value	D.C.		50℃	70℃				
				50℃	70℃						
SF-160	S	50	36	34	27	135	90	160	33~27	53~47	
//	//	100	32	32	25	135	90	160	31~25	51~45	
//	//	150	30	30	24	90	60	160	31~25	51~45	
//	//	200	27	27	21	90	60	160	30~22	48~42	
SF-140	S	50	32	34	27	90	60	140	33~27	53~47	
//	//	100	30	32	25	90	60	140	31~25	51~45	
//	//	150	27	30	24	60	40	140	30~22	50~44	
//	//	200	24	24	19	60	40	140	30~22	47~41	
SF-110	S	30 40 50	26	28	22	67.5	45	110	24~18	49~44	
//	//	60 70	22	24	19	67.5	45	110	24~18	48~43	
//	//	80 100	22	24	19	45	30	110	24~18	47~43	
//	//	150	16	18	14.5	45	30	110	22~15	46~42	
SF-80	S	20 25 30	23	25	20	45	30	80	21~14	33~28	
//	//	40 50	20	22	17.5	30	20	80	21~14	31~27	
//	//	60	16	18	14.5	22.5	15	80	17~12	30~26	
//	//	70 80	13	15	12	22.5	15	80	17~12	30~25	
SF-60	S	10 15 20	18	20	16	22.5	15	60	18~13	32~22	
//	//	25 30	16	18	14.5	15	10	60	17~12	26~22	
//	//	40	14	16	12.5	12	8	60	17~12	25~21	
//	//	50 60	9	11	9	8	6	60	15~10	25~20	
SF-50	S	10 15 20	14	16	12.5	12	8	50	17~12	25~21	
//	//	25 30	12	14	11	10	7	50	15~10	25~21	
//	//	40	9	11	9	8	6	50	15~10	25~20	
SF-40	S	5 10 15 20	12	14	11	7.5	5	40	17~10	27~21	
//	//	25 30	8	10	8	7.5	5	40	15~10	25~20	
SF-30	S	5 10 15 20	6	8	7	5	3.5	30	15~8	27~20	
SE-110	S	50 60 70	4	14	11	21	14	110	10~1	35~25	
SE-80	S	50 60 70	4	10	8	11	7.5	80	7~1	31~24	
SE-60	S	10 20 25 30 40 50	4	8	6.5	6	4	60	10~1	30~20	
SE-50	S	10 20 30 40	4	6.5	5	4.5	3	50	8~1	28~20	
SE-40	S	10 15 20 25 30	4	5	4	3	2	40	6~1	26~20	
SE-30	S-L	5 10 15 20 25	2	3	2.5	2	1.5	30	5~0.5	25~20	
SE-20	S-L	5 10 15 20	2	2	1.5	1.5	1	20	3~0.5	19~15	

材 質 B (チタン酸バリウム系) 規格表
 Material-B (Barium) Rating Table

形 名 Model	端子形 Terminal Shape	静 電 容 量 Electrostatic Capacity ±50% (PF)	直 流 電 圧 (常 温) D. C. Voltage		D ^φ ±10% (mm)	T (mm)	H (mm)	備 考 Remarks
			定 格 電 圧 Rated Voltage (KV)	試 験 電 圧 Test Voltage (KV)				
BE-60	S	20,000	4	8	60	4~1	23~20	
//	//	10,000	5	10	60	8~4	27~23	
//	//	5,000	6	12	60	9~5	28~24	
BE-50	S	15,000	2.5	5	50	4~1	23~20	
//	//	8,000	3	6	50	6~2	25~21	
//	//	5,000	4	8	50	7~2	26~21	
//	//	3,000	5	10	50	7~3	26~22	
//	//	2,000	5	10	50	7~3	26~22	
BE-40	S	10,000	2.5	5	40	4~1	23~20	
//	//	5,000	3	6	40	5~1	24~20	
//	//	3,000	4	8	40	5~1	24~20	
//	//	2,000	4	8	40	6~2	25~21	
//	//	1,000	4	8	40	6~2	25~21	
BE-30	S-L	10,000	1	2	30	3~0.5	22~19	
//	//	5,000	2	4	30	4~1	23~20	
//	//	3,000	3	6	30	5~1	24~20	
//	//	2,000	3	6	30	5~1	24~20	
//	//	1,000	3	6	30	5~1	24~20	
BE-20	S-L	2,000	2	4	20	5~1	20~16	
//	//	1,000	2	4	20	4~1	19~16	

材 質 (R) Material

定格電圧 (kv) Rated Voltage		定格電力容量 Rated Electric Capacity 50°C (KVA)	標 準 静 電 容 量 (PF) Standard Electrostatic Capacity														
H.F 尖頭值 Peak value	D.C. 50°C		50	100	150	200	250	300	400	500	600	700	800	1000	1200	1500	2000
30	25	90							RF-110			RF-140					
25	21	90												RF-140			
	21	45				RF-110											
18	15	45								RF-110							
	15	30					RF-80										
16	13	22				RF-80											
15	13	90															RF-140
14	12	30											RF-110				
	12	15					RF-60			RF-80							
13	11	10					RF-50										
	10	30															RF-110
	10	15										RF-80					
	10	7.5							RF-60								
	10	6					RF-40										
10	8	22															RF-110
	8	67.5															RF-140
9	8	15												RF-80			
	7	15															RF-110
7	6	15															RF-80
	6	7.5															
	6	6							RF-50								
	5	7.5												RF-60			
6	5	6								RF-50							
	5	4.5								RF-40							
	5	3								RF-30							
	11	10															
	8.5	10															
	8.5	7															
	7	7															
	7	5								RE-60							
	6	10															RE-110
	6	7															RE-80
2	6	5															
	6	4															
	6	4								RE-60							
	5	5															RE-60
	5	4															
	5	3															
	5	2															
	3.5	2.2															
	3	2															
	3	1.5															
	2	1.5															

材 質 Material (S)

定格電圧 (kv) Rated voltage		定格電力容量 Rated Power Capacity 50℃ (KVA)	標準 静 電 容 量 (pF) Standard electrostatic capacity													
高周波 尖頭値 Peak value	直流電圧 D.C voltage 50℃		5	10	15	20	25	30	40	50	60	70	80	100	150	200
36	34	135							SF-160							
32	34	90						SF-140						SF-160		
30	32	90												SF-140		
	30	90												SF-160		
27	30	60												SF-140		
	27	90													SF-160	
26	28	67.5						SF-110								
24	24	60														SF-140
23	25	45						SF-80								
22	24	67.5											SF-110			
	24	45											SF-110			
20	22	30							SF-80							
18	20	22.5						SF-60								
16	18	45														SF-110
	18	22.5											SF-60			
14	18	15						SF-60								
	16	12						SF-50								
13	15	22.5							SF-60							
12	14	10							SF-50							
	14	7.5							SF-40							
9	11	8								SF-50			SF-60			
8	10	7.5							SF-40							
6	8	5							SF-30							
4	14	21														SE-110
	10	11														SE-80
	8	6														SE-60
	6.5	4.5														SE-50
	5	3														SE-40
2	3	2														SE-30
	2	1.5														SE-20

材 質 Material (B)

W.V D.C	静電容量 Electrostatic capacitance	1,000 PF	2,000 PF	3,000 PF	5,000 PF	8,000 PF	10,000 PF	15,000 PF	20,000 PF
	6 k				BE-60				
	5 k		BE-50	BE-50			BE-60		
	4 k	BE-40	BE-40	BE-40	BE-50				BE-60
	3 k	BE-30	BE-30	BE-30	BE-40	BE-50			
	2.5 k						BE-40	BE-50	
	2 k	BE-20	BE-20		BE-30				
	1 k						BE-30		